

Undermount drawer slide push to open OFPO

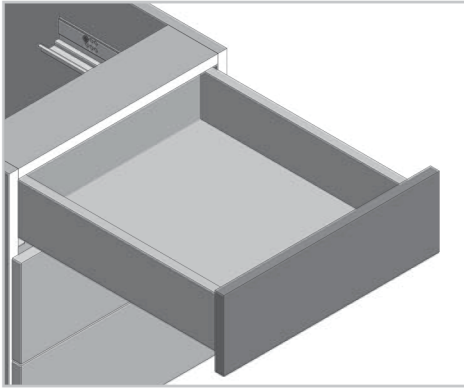

APPLICATION



CHARACTERISTICS

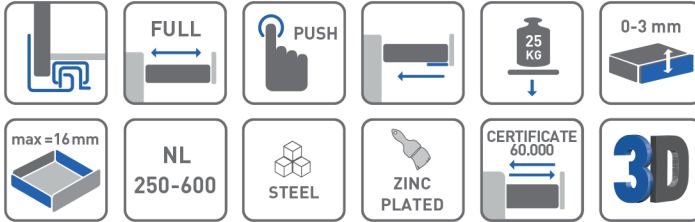

PACKING



ADDITIONAL INFORMATION

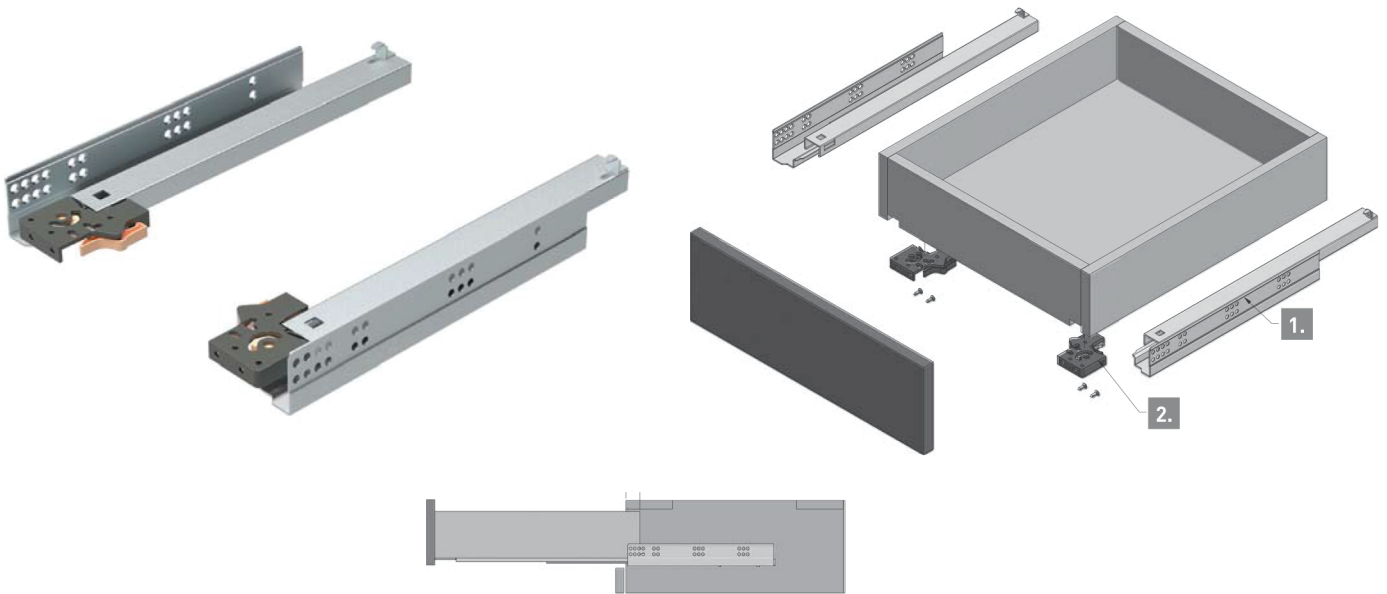

drawer width

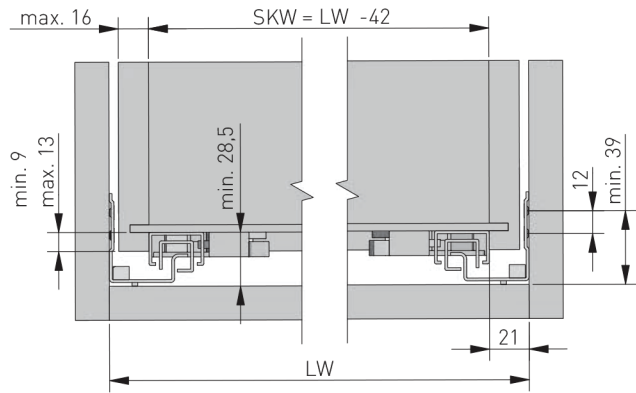

LW = inner cabinet width

SKW = inner drawer width

standard drawer

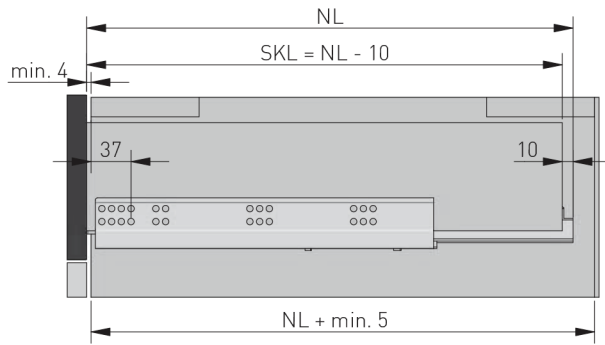

inner drawer

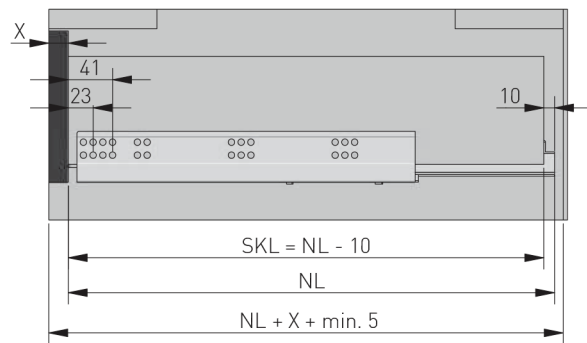

X = drawer front thickness SKL = drawer depth

mounting dimensions

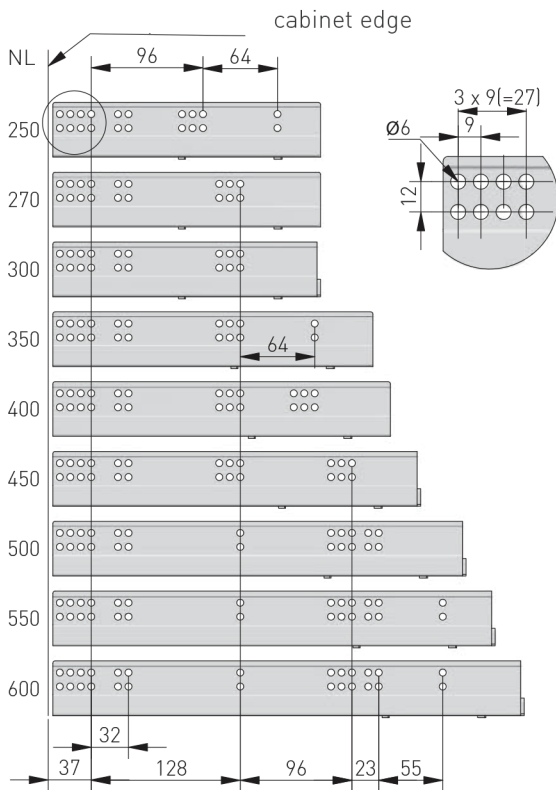

NL = nominal slide length

drawer preparation

